

NÍZKÝ NÁRAZNÍK S VYSOKOU ODOLNOSTÍ - RF 70

INSTALACE



M16 POZINKOVANÁ OCEL

S ROZPÍNACÍM ŠROUBEM

Ø16 mm

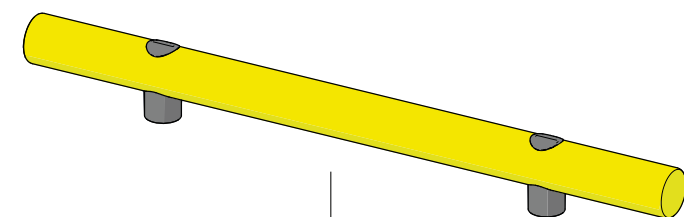

UPOZORNĚNÍ
VZDÁLENOST INSTALACE ZÁVISÍ
NA RÝCHLOSTI A HMOTNOSTI
VOZIDLA

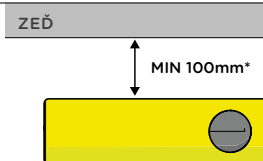

1

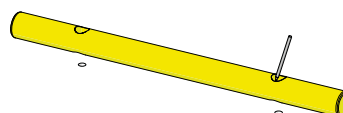

2

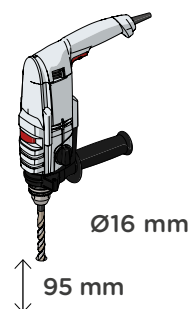

3

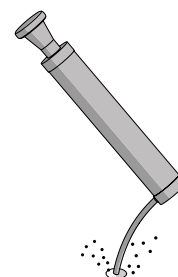

4

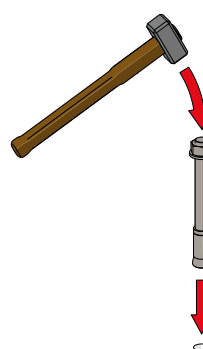

NÍZKÝ NÁRAZNÍK S VYSOKOU ODOLNOSTÍ - RF 70

INSTALACE



M16 POZINKOVANÁ OCEL

S ROZPÍNACÍM ŠROUBEM

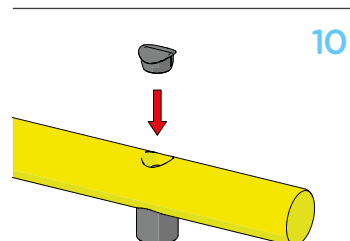
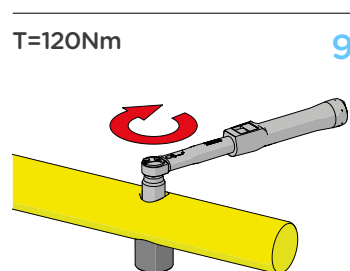
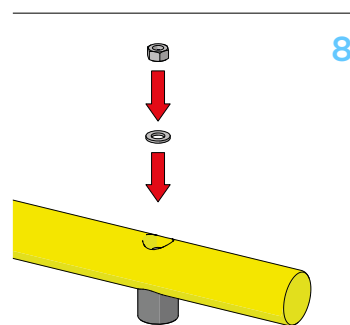
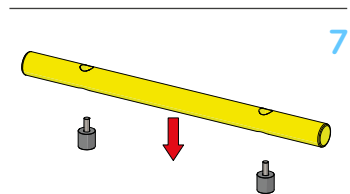
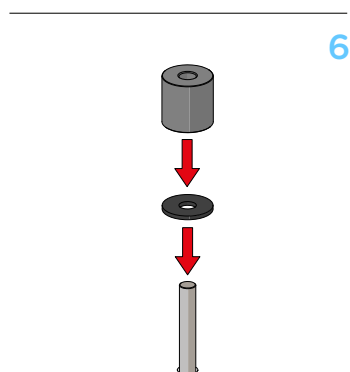
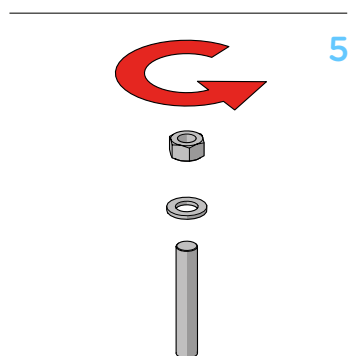

NÍZKÝ NÁRAZNÍK S VYSOKOU ODOLNOSTÍ - RF 70

INSTALACE



M16 POZINKOVANÁ OCEL KOTVA

S CHEMICKOU KOTVOU

CHEMICKÁ KOTVA

Ø18 mm

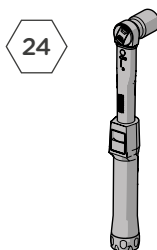

24

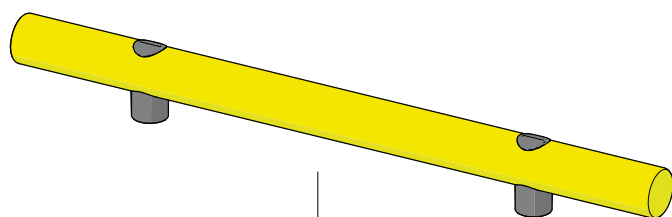

UPOZORNĚNÍ
VZDÁLENOST INSTALACE ZÁVISÍ NA RYCHLOSTI A HMOTNOSTI VOZIDLA

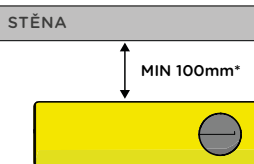

1

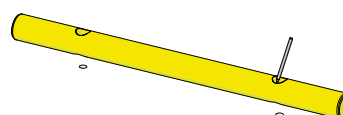

2

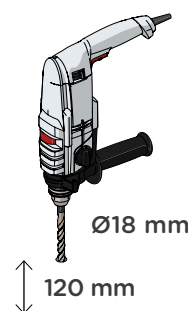

3

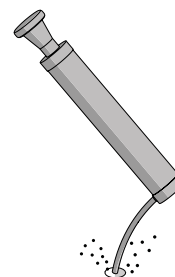

4



2/3

NÍZKÝ NÁRAZNÍK S VYSOKOU ODOLNOSTÍ - RF 70

INSTALACE



M16 POZINKOVANÁ OCEL KOTVA

S CHEMICKOU KOTVOU

